



05/2019



Our management system is certified in accordance with the quality standards ISO 9001, IATF 16949 and ISO 14001. All products are listed in the International Material Data System (IMDS).



SOLUTIONS BEYOND TAPE

Process optimization through individually tailored solutions

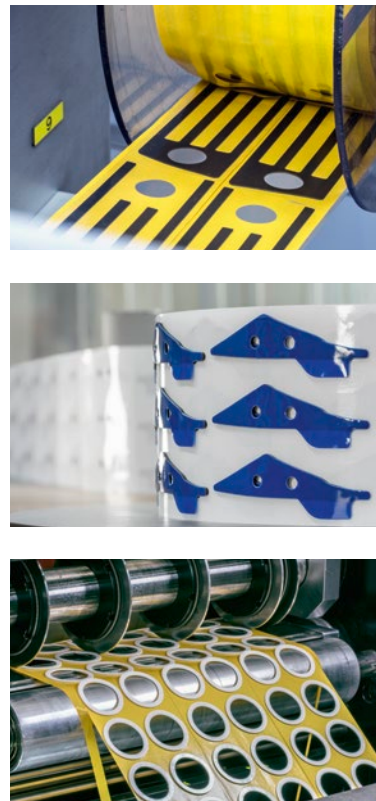

SAMPLE PRODUCTS AND APPLICATIONS

Try our proven technology for yourself

On the following pages you can see examples of solutions that we have already developed for our partners. For more information feel free to get in contact with us, a member of our team will be happy to find the best solution for your application.

Individual die cuts for your application

tesa® product solutions are processed to the exact dimension using a network of qualified converting partners. Our wide variety of individually designed and customized die cuts can greatly assist with your product development, process planning and calculation costs.

Our products ensure that:

- Your production process is smooth and efficient
- Your employees can process all orders effectively
- A consistently high quality result is achieved

By using our adhesive tapes, you have the opportunity to pair your production materials with the relevant chemical adhesive. Our tapes are tailored to your individual manufacturing process and quality requirements for almost any product development. Even in the most demanding requirements, we support you in finding the optimal solution.

Converting is used in a variety of processes, such as:

- Cutting
- Punching
- Lasering
- Laminating

By adapting each die cut to your process you can create individual and unique products. Correctly integrating die cuts as rolls, sheets, family sheets with finger-lift tabs or positioning holes can effectively produce quality end products. We support you in assessing all available options and understanding what is the best solution for you.

Process optimization through individually tailored solutions

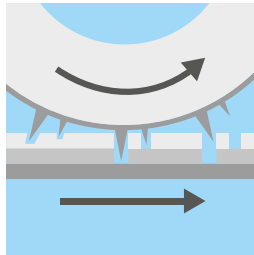

Multi-level rotational cutting

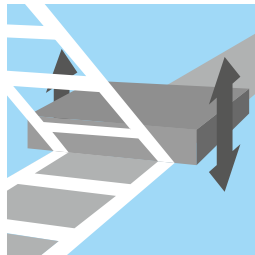

Flatbed die and kiss cutting

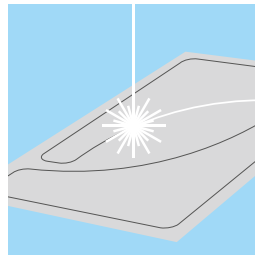

Die cuts lasered onto rolls or sheets

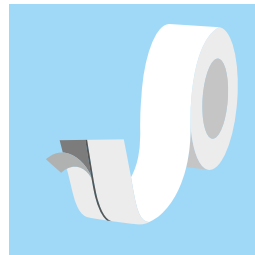

Seperable paper layer with possible divisions

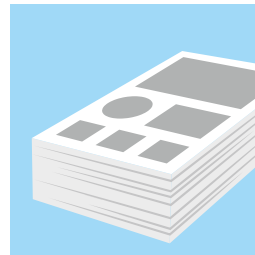

Family sheets (different shapes on the same sheet)

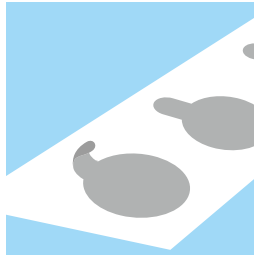

Finger lift with grabbing tab

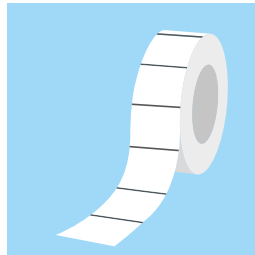

Butt cutting, with or without space between objects

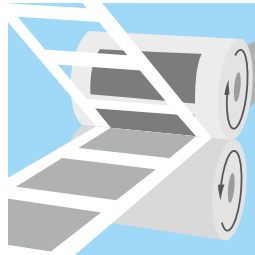

Rotary die cutting with hole punching



Die cuts on rolls with positioning tabs

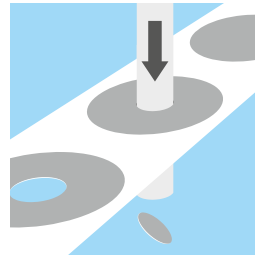

Hole punching with automatic waste removal

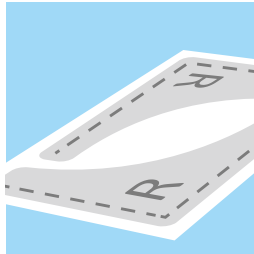

Die cuts with print or tape as application aid

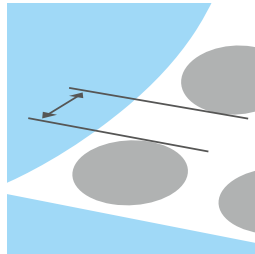

Individually definable gaps between die cuts

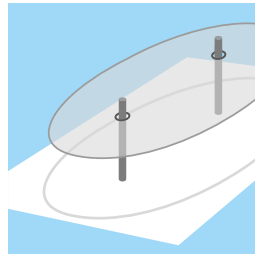

Positioning features to aid marking

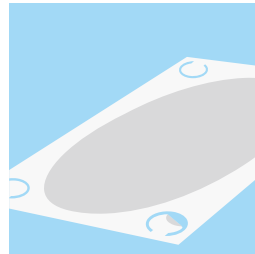

Temporary fixing aid, which keeps the cut out in place

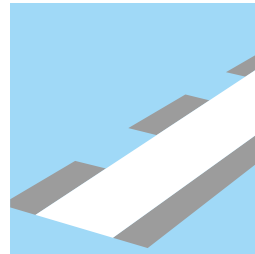

Intermittent adhesive zones can be produced

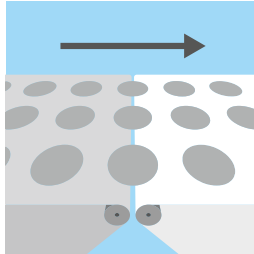

Die cut can be easily transferred to another backing

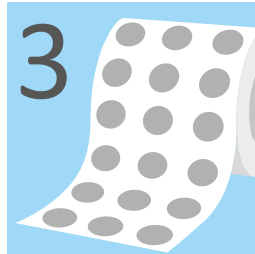

Die cuts placed in multiple rows along the same sheet

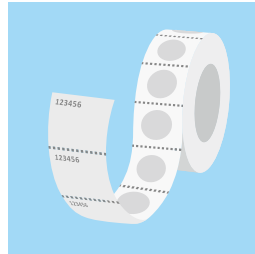

Sections of roll can be perforated for easy separation

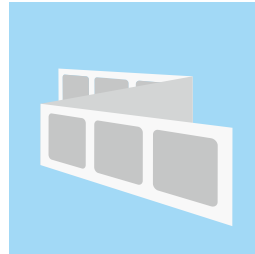

Leporello (fan) fold, with or without margin

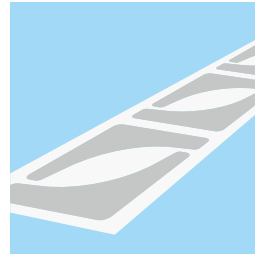

Die cuts interlaced to save material

Roll with double layered die cuts and positioning holes



Product details and requirements

- A die cut bonds two substrates (polar/non-polar) together and is extremely thin to ensure the smallest possible gap between substrates. It must be perfectly positioned as there is minimal margin for error.
- The covering liner must be physically treated to appropriately adjust its properties for each application. As well as accurate placement, careful consideration for the direction and spacing of the die cut must be given to guarantee the desired outcome.
- The tape liner protects the die cut from damage and ensures that the measurement sensor is correctly positioned over the right area, making the entire automated process possible.

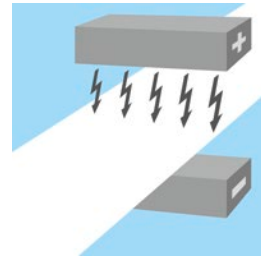

Physical or chemical pre-treatment

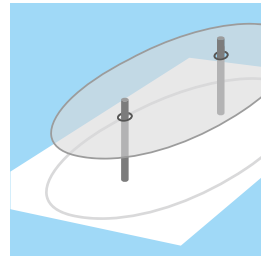

Positioning features to aid marking

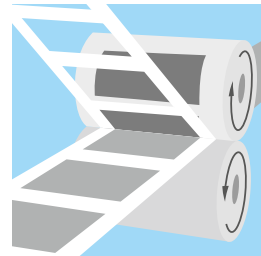

Rotary die cutting with hole punching

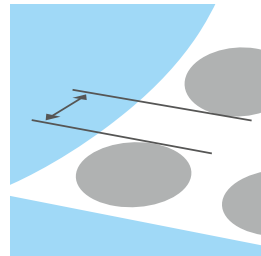

Individually definable gaps between die cuts

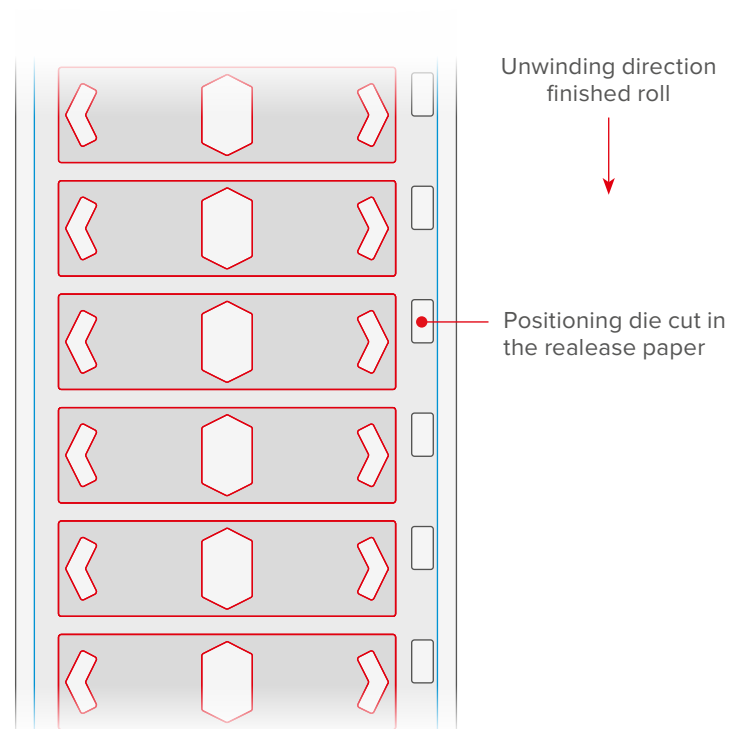

Die cuts as a roll with partially punched holes



Product details and requirements

- The die cut is used as fixation during the assembly of attachment parts. The tape fits well with uneven surfaces, resulting in good adhesion levels.
- The die cut is covered with a paper liner on either side. One one side, the liner and tape have been removed in a lattice formation, but the second layer on the other side remains intact. This results in two separate parts that match each other perfectly.
- This process is partially automated. The holes on one side are necessary to fully equip the parts for their relevant application. This design optimally supports the process and ensures error free production.

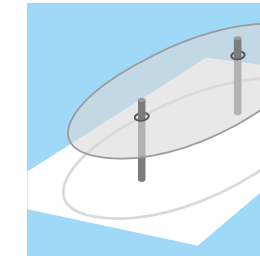

Positioning features to aid marking

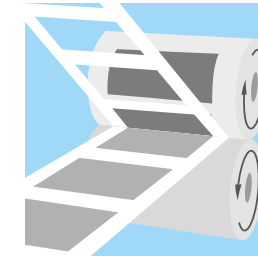

Rotary die cutting with hole punching

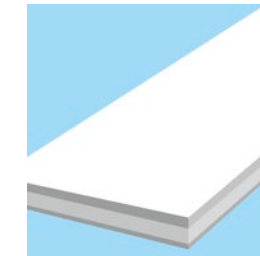

Lamination of various materials

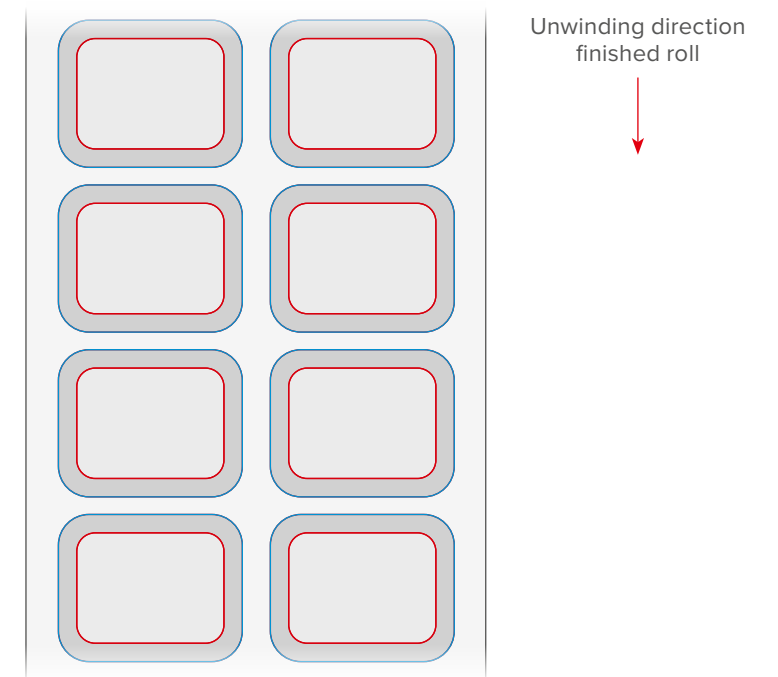

Individually separated and stacked die cuts



Product details and requirements

- The die cut protects delicate and varnished parts from damage. This prevents premature corrosion and ensures that the parts remain aesthetically pleasing for a long time. Moreover, this tape is transparent, very flexible and has great adhesion.
- The die cuts come as a roll with a fingerlift tab on one side for easier handling. A laminated protective layer prevents any contamination of the die cut adhesive, which increases the precision of the application. When correctly applied and with the lamination removed, the die cut is barely visible.
- Our products can be fully integrated into a fluid manufacturing process, ensuring that production remains as efficient as possible.

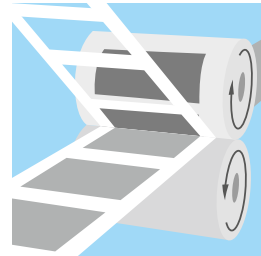

Rotary die cutting with hole punching

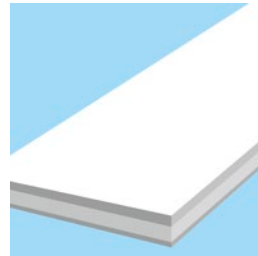

Lamination of various materials

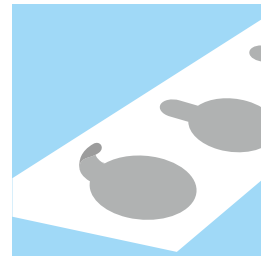

Finger lift with grabbing tab

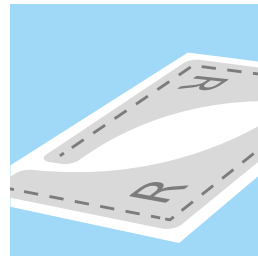

Die cuts with print or tape as application aid

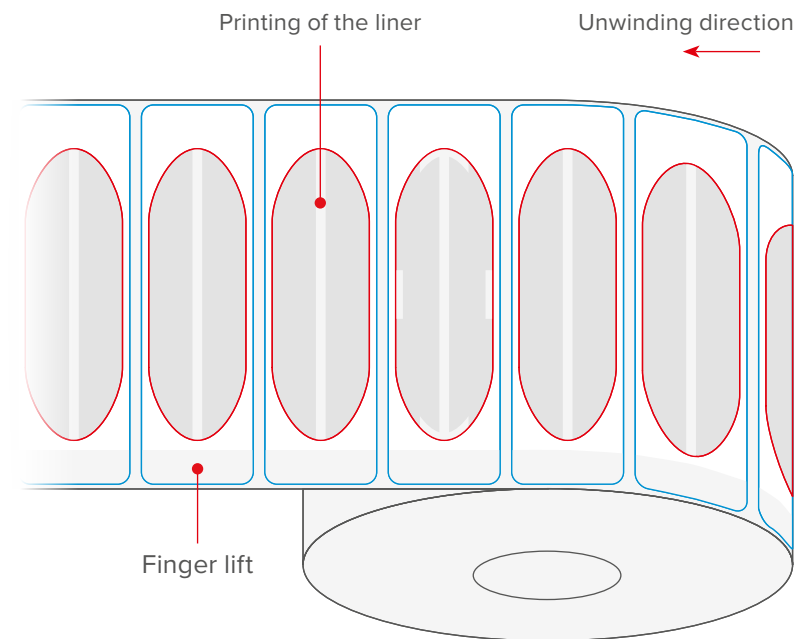

Individually separated and stacked die cuts



Product details and requirements

- The die cut secures lightweight attachments in place and serves as guidance for production steps further down the line. The selected tape is residue free and quick to remove.
- Each die cut is designed in a pair to ensure that all parts are used. The application process is therefore guided and secured.
- The die cuts come as a roll and have a perforated line in the liner itself, so they can be easily separated and individually applied. There is a finger lift tab on one side of the die cut, which assists with handling and removal.

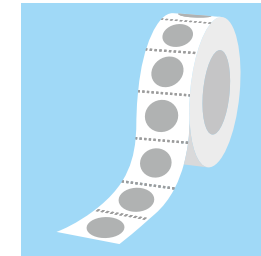

Die cuts as a roll, perforated for easy separation

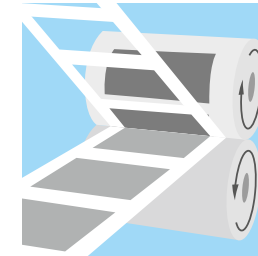

Rotary die cutting with hole punching

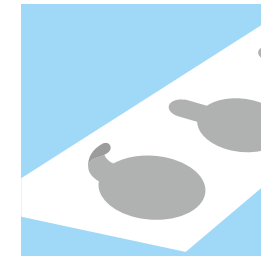

Finger lift with grabbing tab

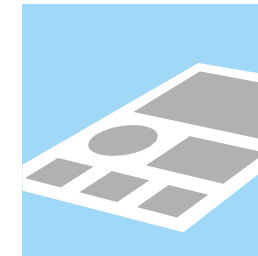

Family sheets (different shapes on the same sheet)

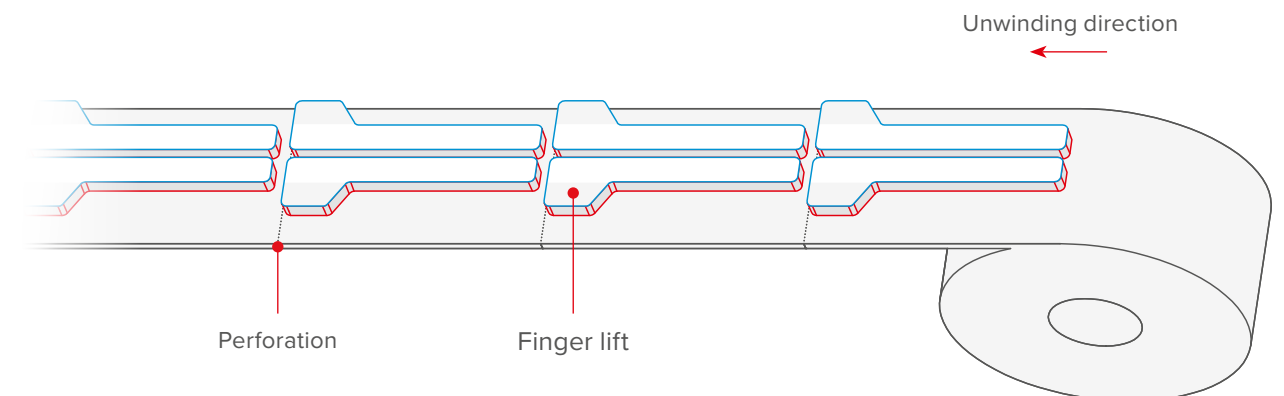

Die cuts as a roll with application assistance



Product details and requirements

- The multilayered die cut covers and protects the substrate during the varnishing process. Our die cuts have a high temperature resistance and produce a residue and tear free removal
- To optimize material usage, each die cut is placed very accurately next to one another on the roll, even they are irregular in shape. To aid application, the die cut is covered with a foil that serves as a guide and finger lift.
- Due to the applicator foil, the adhesive of the die cut is never directly touched or damaged during the application, which ensures optimal adhesion to the substrate. This foil is removed immediately after placement and does not interrupt the rest of the process.

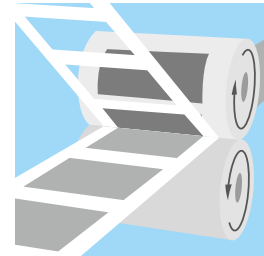

Rotary die cutting with hole punching

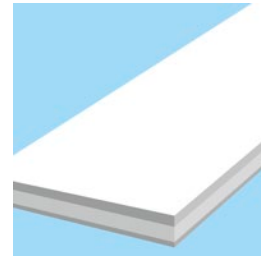

Lamination of various materials

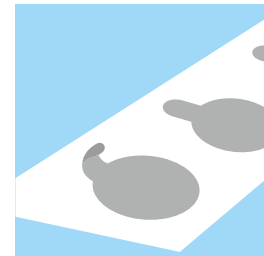

Finger lift with grabbing tab

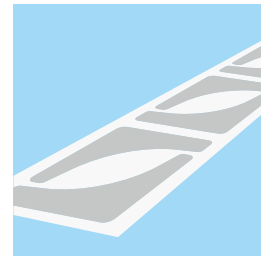

Die cuts interlaced to save material

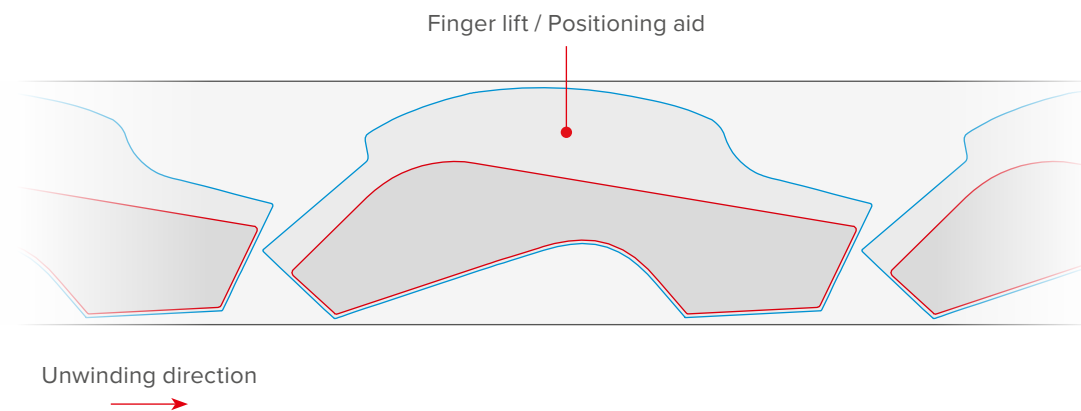

Die cuts with perforation and finger lift



Product details and requirements

- The die cut protects the steel engraving against dirt and corrosion. It is transparent to ensure a precise application, because the engraving stays permanently visible.
- For each working process 6 die cuts are taken off the roll with the assistance of the perforated lines. This results in family sheets i.e. where differently shaped die cuts are on the same sheet. The die cuts, although separately placed, are all on the same liner. The presence of two integrated finger lifts means that the adhesive of the die cut is never directly touched or damaged during the application. The separable paper layer with divisions ensures optimal adhesion to the substrate.
- The perforation ensures that the correct amount of die cut is always used. The family sheet guarantees a secure application process.

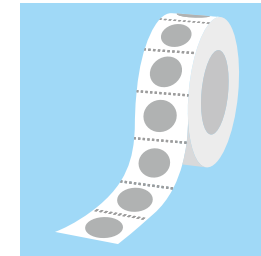

Die cuts as a roll, perforated for easy separation

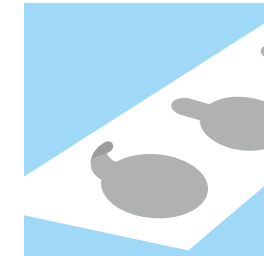

Finger lift with grabbing tab

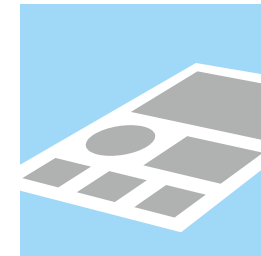

Family sheets (different shapes on the same sheet)

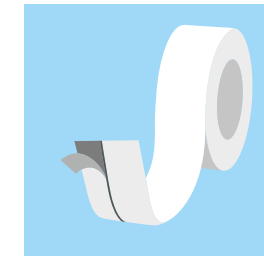

Separable paper layer with possible divisions

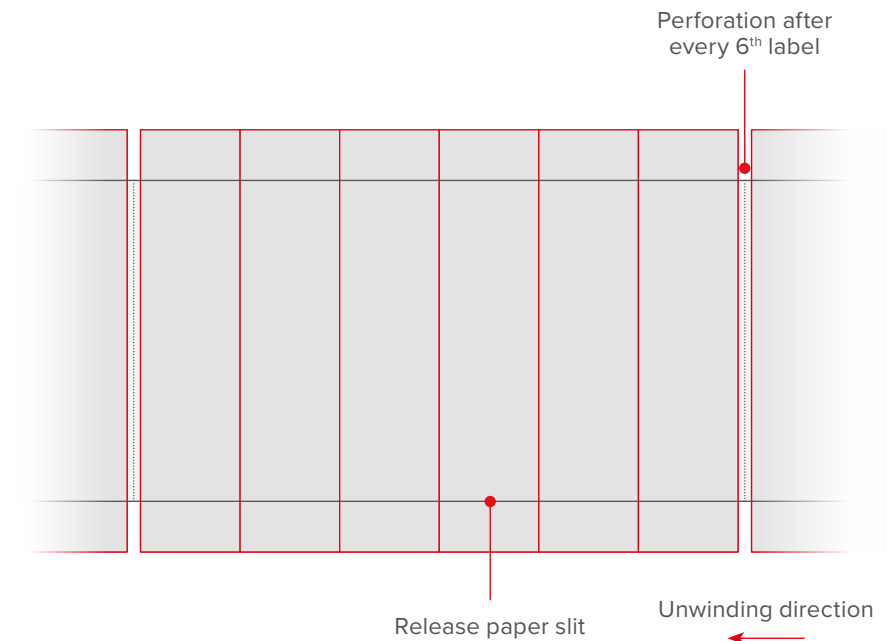

Die cuts with perforation and separable liner



Product details and requirements

- The die cut is used to stop objects from jamming whilst simultaneously minimising rattling and noise. The die cut comes as a roll with a flexible backing and is easy to separate due to the perforation.
- The partial adhesive coating gives the die cut its flexibility. To assist with the application the die cut has a slit in the liner with retaining lugs, which makes for easier handling and a controlled application.
- The slitting guides clearly mark how the process must be carried out step by step, meaning all stages of the application are done properly and in the correct order.

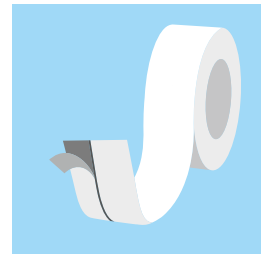

Seperable paper layer with possible divisions

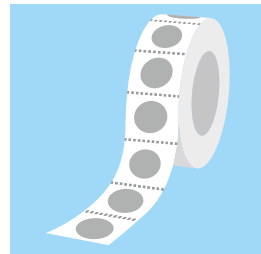

Die cuts as a roll, perforated for easy separation

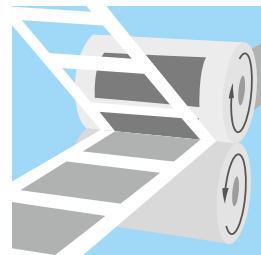

Rotary die cutting with hole punching

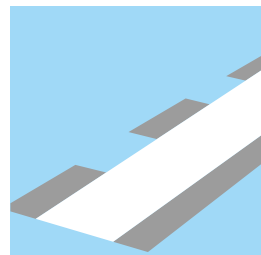

Intermittent adhesive zones can be produced

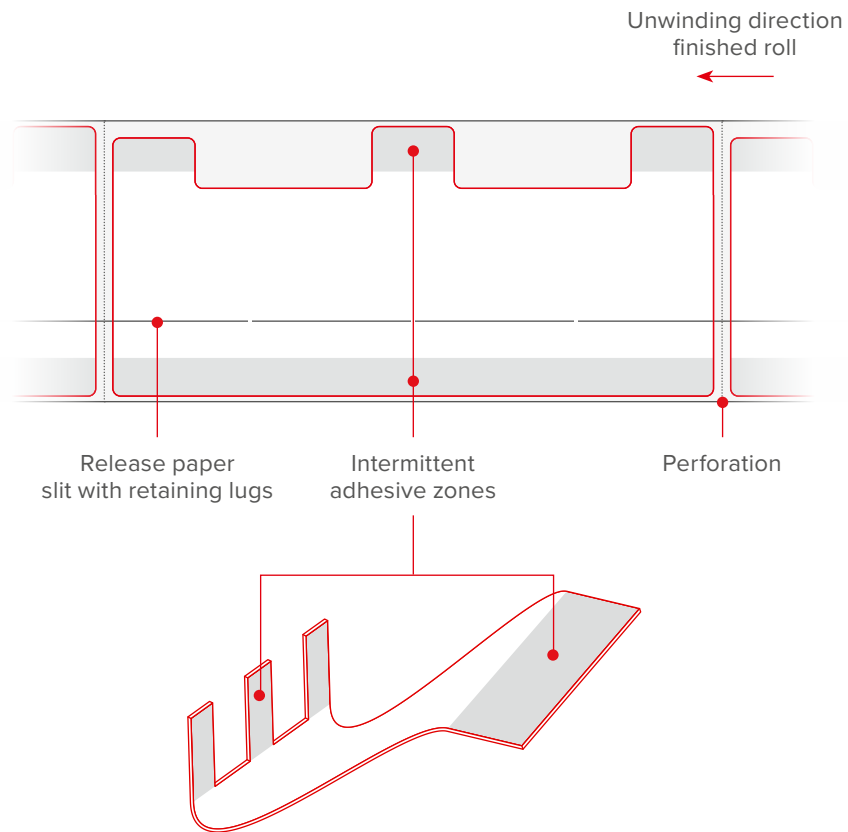

Individually separated and stacked die cuts



Product details and requirements

- The die cut is water and chemical resistant, which permanently protects it from damage or contamination. The transparency of the die cut helps with positioning large ones such as this.
- Due to the size of this die cut, the liner is partitioned into three sections. Instructions and the material number are printed on the liner, which ensures the process is done correctly.
- In addition, the die cut can be repositioned during the application.

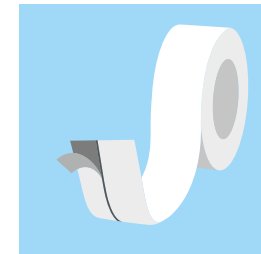

Seperable paper layer with possible divisions

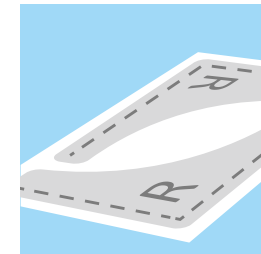

Die cuts with print or tape as application aid

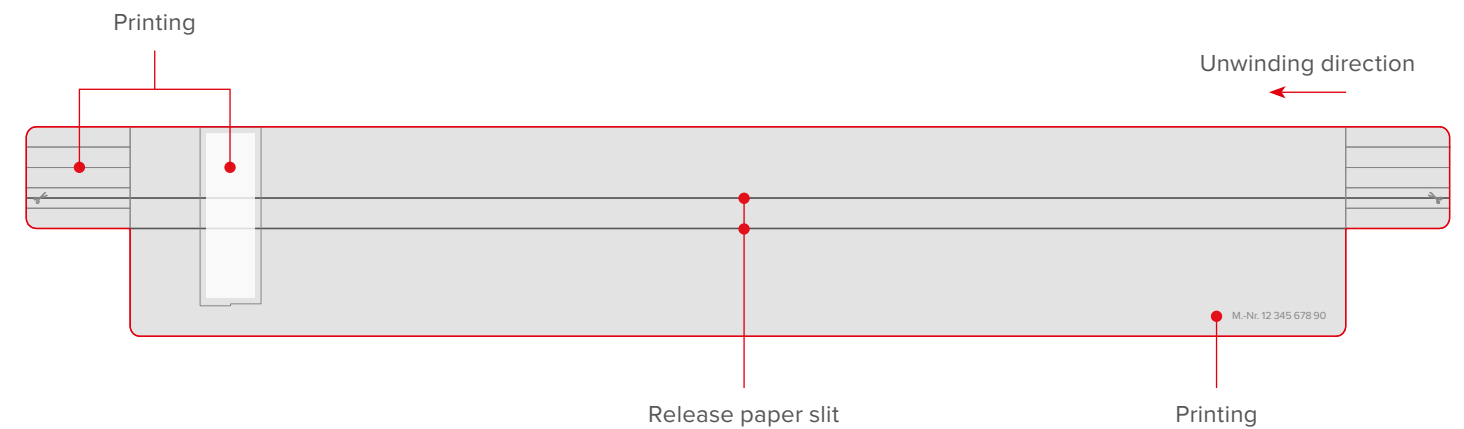

Separated, stacked and hole punched die cuts

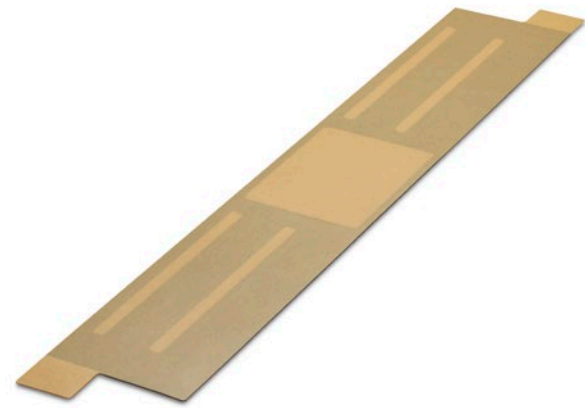

Product details and requirements

- The die cuts are delivered separately (i.e. not on a roll) and have already been hole punched. The material has dampening properties.
- The die cut has a paper liner on both sides. This liner acts as a finger lift and offers guidance to the applicator. One of the punched out holes serves as a marker and indicates when the die cut is correctly positioned.
- The goods are delivered in a specially prepared, statically charged packaging.

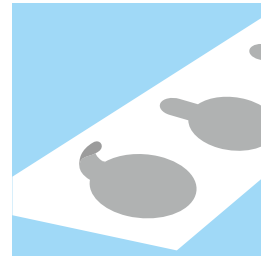

Finger lift with grabbing tab

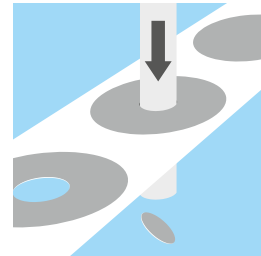

Hole punching with automatic waste removal

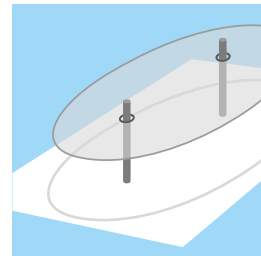

Positioning features to aid marking

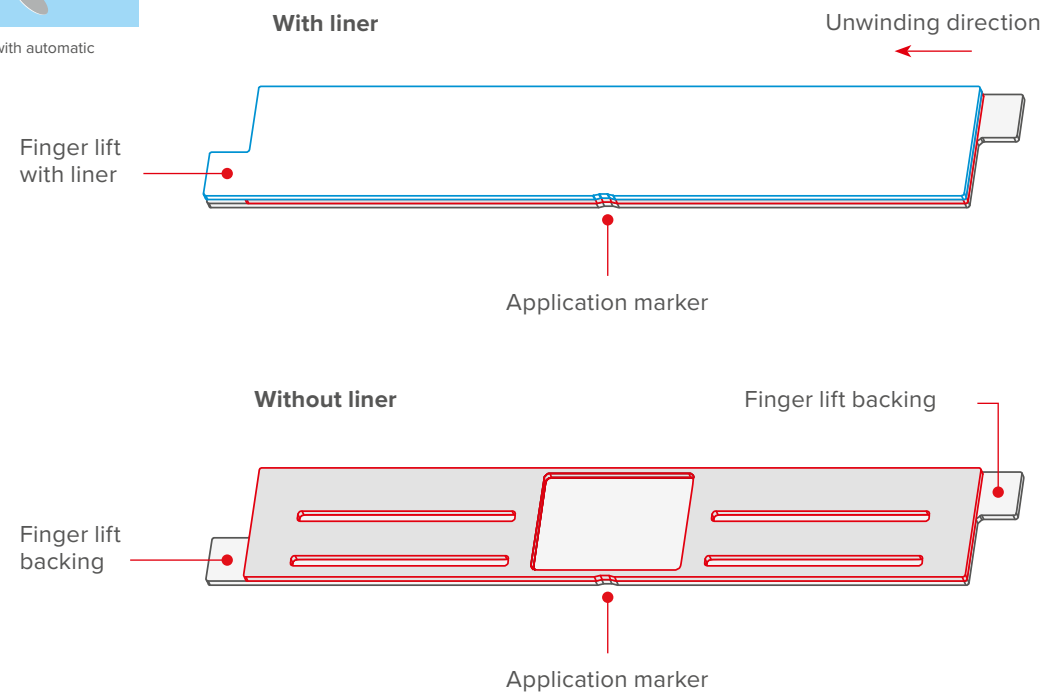

Perforated die cuts as a roll with positioning assistance



Product details and requirements

- The die cut bonds two substrates with different expansion coefficients in already existing production processes. It is therefore important, that the correct kind of die cut is found for the relevant production process and that the adhesive tape will meet the technical demands of the application.
- The die cut roll is smoothly integrated into the production process. The perforation means that each die cut can be easily separated during processing.
- Accurate positioning is ensured by a small hole on each die cut and the finger lift helps with the removal of the liner.

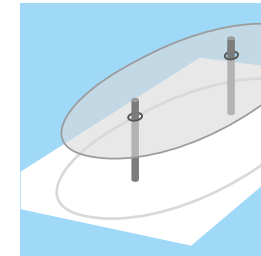

Positioning features to aid marking

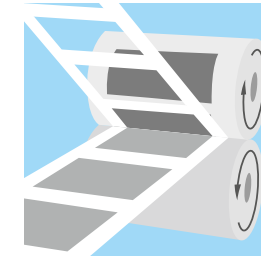

Rotary die cutting with hole punching

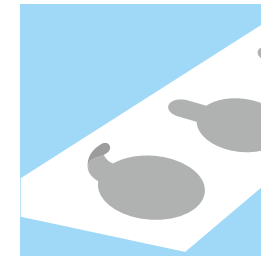

Finger lift with grabbing tab

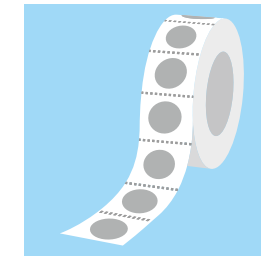

Die cuts as a roll, perforated for easy separation

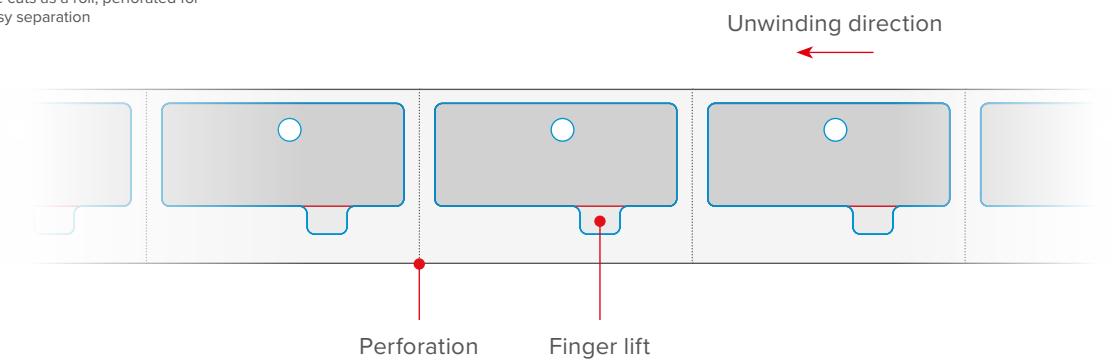

Individually separated and stacked die cuts



Product details and requirements

- The delivery of the die cut as a roll ensures the high quality of each piece, as they are better protected when packed together. The material is appropriate for varnishing.
- Although the die cuts come on a roll, each individual piece must be applied separately. The die cuts are secured on the roll by extremely small fastening pins and the slitted liner assists with the application. The retaining tabs ensure that the die cut is removed cleanly without damaging the finished product.
- Small parts of the adhesive will remain covered by the liner throughout the application in order to protect extra sensitive areas of the substrate. The adhesion free zone also functions as a finger lift after the varnishing process, so the recently varnished area remains untouched and damage free.

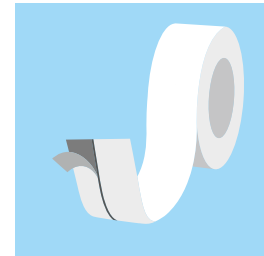

Seperable paper layer with possible divisions



Die cuts on rolls with positioning tabs

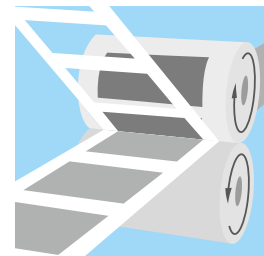

Rotary die cutting with hole punching

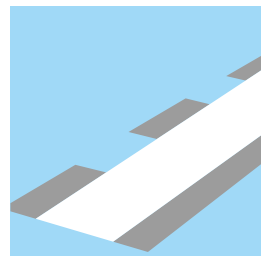

Intermittent adhesive zones can be produced

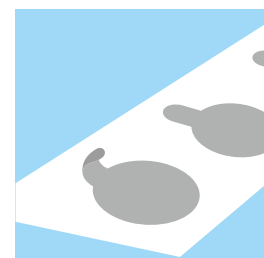

Finger lift with grabbing tab

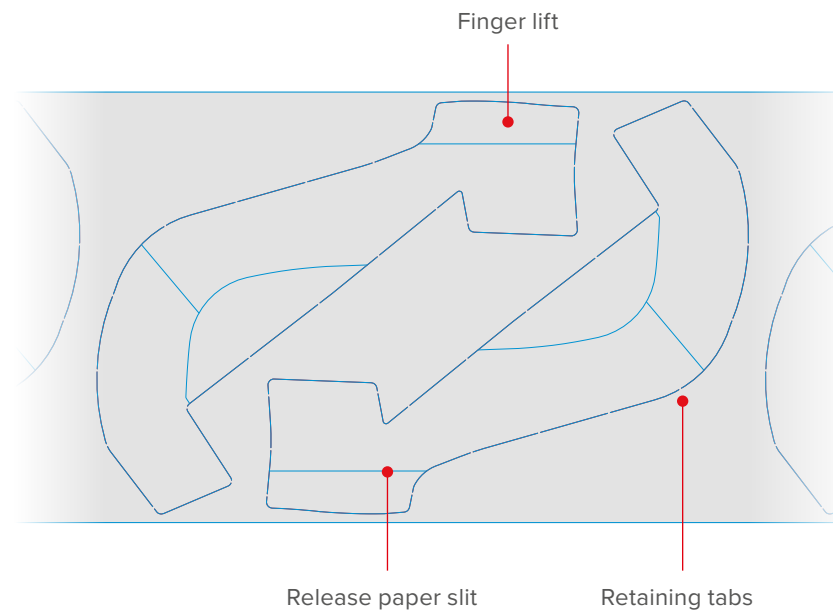

USAGE GUIDELINES

Surface preparation

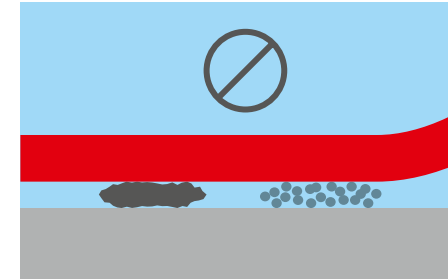

Removal of contaminants

The bonding surface must be clean and free of dust, grease, oil and moisture. Only use clean cloths and material compatible cleaning agents to remove impurities. Particularly coarse, dusty or grainy impurities are best removed with a white lint-free cloth.



Cleaning with water and solvents

Water soluble dirt can be removed with water and light detergents. Other impurities e.g. oil, grease, wax and release agents can strongly reduce the bonding capacity if not properly removed. Therefore, extra care must be taken to remove these impurities with an appropriate solvent. Suitable solvents are:

- tesa® 60040 Industry Cleaner
- Isopropanol
- Isopropanol + water (1:1 ratio)
- Acetone or methyl ethyl ketone (butanone)

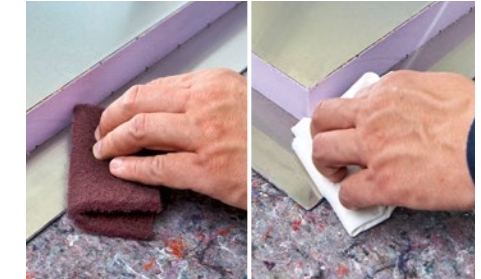

Mechanical cleaning

Loose oxides (such as rust) and poorly adhered coatings should be removed with a suitable abrasive. The surface should remain flat and only be roughened slightly. Do not to damage any anti-corrosion coatings that the surface may have. Afterwards, the surface must be cleaned again to ensure any leftover dust from the abrasive material is removed.

Application

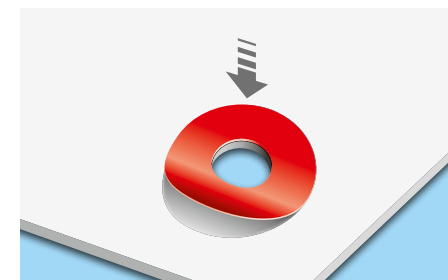

Applying the adhesive tape

When applying the adhesive tape care must be taken to avoid air pockets. To achieve this, maintain firm and even pressure when rolling the tape out from one end to the other.

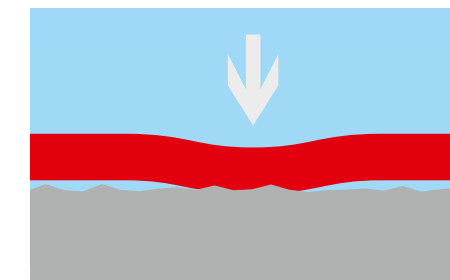

Pressure

An optimal bond strength is achieved when the tape is rolled out with a weight of 1kg per 10 mm of width. For the joining of two components, a contact pressure of at least 0.5bar (equivalent to 5N/cm²) must be ensured at the joint. Pressures of 2 bar or more are ideal.

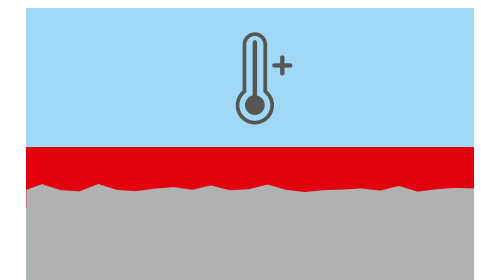

Processing temperature

At room temperature the tape meets the optimal conditions to completely bond to the surface structure. At lower temperatures (below 10°C) the adhesive becomes stiffer and optimum adhesion becomes difficult to reach. As a general rule, tape should be applied at temperatures between 10°C and 40°C.

tesa® products prove their impressive quality day in, day out in demanding conditions and are regularly subjected to strict controls. All technical information and data above mentioned are provided to the best of our knowledge on the basis of our practical experience. They shall be considered as average values and are not appropriate for a specification. Therefore tesa SE can make no warranties, express or implied, including, but not limited to any implied warranty of merchantability or fitness for a particular purpose. The user is responsible for determining whether the tesa® product is fit for a particular purpose and suitable for the user's method of application. If you are in any doubt, our technical support staff will be glad to support you.